

Installation and  
User Manual  
**TOUCHLINE** Ovens

---

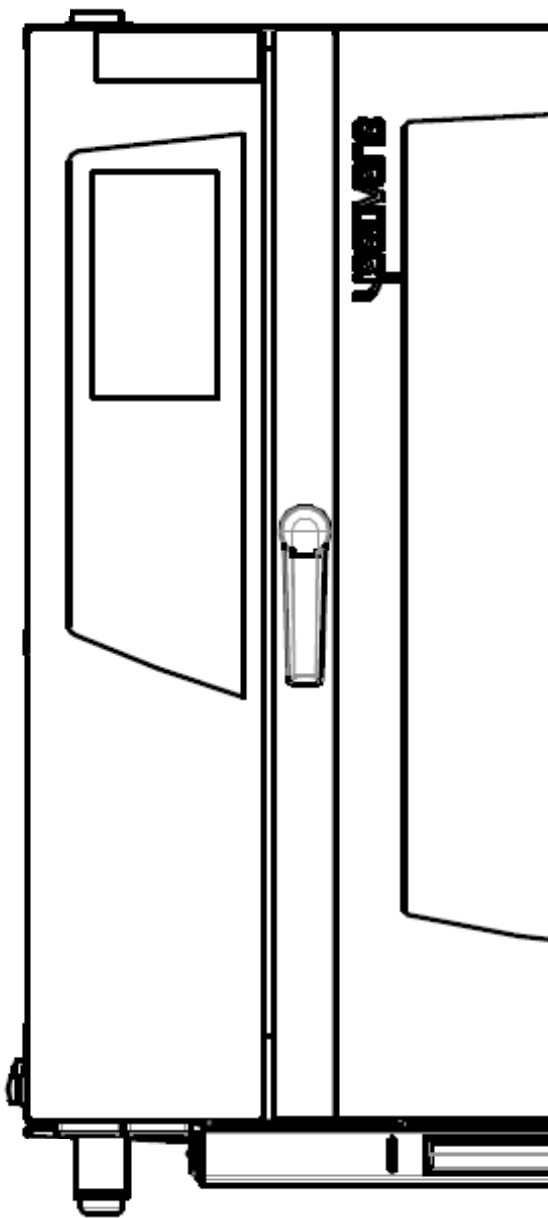

**[www.yesovens.it](http://www.yesovens.it)**

## Index

---

INTRODUCTION	P. 4
GUIDE TO READ INSTRUCTIONS	P. 4
GENERAL INFORMATION	P. 5
DANGER ICONS	P. 7
TECHNICAL DATA SHEET	P. 8
HANDLING, TRANSPORT AND UNLOADING	P. 18
INSTALLATION INSTRUCTIONS	P. 22
INSTRUCTIONS FOR USE	P. 31
CLEANING AND MAINTENANCE	P. 40
INSTRUCTIONS FOR THE USER	P. 46
ALARMS AND WARNINGS	P. 49



## INTRODUCTION:

- This user manual refers exclusively to the touch ovens EGO and STAR.
- This manual is addressed to any person fulfilling any role, appointed and/or authorised to use and/or run the oven.
- The intended use and stated versions are the only ones allowed by the manufacturer; do not attempt to use the ovens in disregard of the provided instructions. The stated intended use applies only to ovens that are fully efficient from a structural, mechanical and engineering point of view.
- This manual is also addressed to the employer, company's managers and workers in charge that must carefully read it and understand it so that they can use it as a valid help to fulfil at least part of the obligations that the laws and regulations in force impose on them with regard to health and safety in the workplace.
- The employer, in whose production site the oven is installed, as well as managers and workers in charge of it, must guarantee for the operators responsible for the various specific functions, appropriate information, education and, if required, training (that must take into account the level of acumen that can reasonably be expected from those operators) about its correct and safe use and the general and specific risks of the workplace and/or task; this manual can be a valid help in fulfilling this delicate task.

## GUIDE TO READING INSTRUCTIONS

Pay particular attention to the bold or underlined texts or to texts in a LARGER font as these refer to particularly important operations or information.

The manual must be kept until the machine's final disposal in a suitable location, in order that the manual is always available for consultation in the best possible condition. In case of loss or deterioration, a replacement copy must be requested from the manufacturer or retailer.

# GENERAL INFORMATION

Read the instructions in this booklet carefully before installing and use the oven, in order to be aware of the precautions that must be followed to:

- install the oven;
- maintain and clean it;
- use it in the best possible way.

This equipment must be used only as expressly intended, i.e. to cook/bake or heat food; any other use shall be considered improper because not in conformity with the intended use and therefore dangerous.

The equipment is designed for professional use and must be used by qualified personnel.

Before leaving the factory, this equipment has been tested and set up by expert and specialised personnel, in order to guarantee best performance.

Installation and/or any repairs or adjustments that may subsequently become necessary must be performed with maximum care and attention by qualified personnel;

It is recommended to always contact your dealer and specify the problem, model and serial number of the oven in your possession.

In case of repair and/or replacement of any components, corrective maintenance, fault or malfunction it is necessary professional know-how and use only original spare parts, penalty the extinction of the guarantee and of the responsibility of the manufacturer (refer to action, contact only personnel authorised by the manufacturer with the codes listed in the attached document).

Before installation, check that power and water values are compatible with the values printed on the data plate.

## KEY SIMBOLS



HAZARD



FIRE HAZARD



SHOCK HAZARD



BURN HAZARD



TERMINAL  
BOARD  
GROUNDING



PAY  
ATTENTION



EQUIPOTENTIAL  
RING

The oven's electrical safety is guaranteed provided, it is connected to an efficient grounding system (please remember this must be checked regularly), which must comply with the national and local regulations in force at the time.

When in operation, the oven must be used and monitored by specifically trained personnel only.

Avoid installing the oven near heat sources such as: fryers, open fires, etc. Do not obstruct suction vents for any reason; do not prevent heat dissipation and do not obstruct the oven steam discharge system.

Ask the installer to provide instructions on the correct use of the water softener/descaler (caution: a less than perfect resin regeneration process may cause corrosion in the equipment).

Before operating the oven for the first time, it is necessary to clean it accurately - externally it must be only cleaned with a wet cloth; the inside of the cooking chamber must be cleaned with water; in any case, never use steel wool to clean the oven.



**Failure to comply with these fundamental rules may compromise the oven's safety and harm the user. The manufacturer declines all liability in the case of non-compliance with the instructions provided in this manual by either the user or the installer, and any accidents or damage caused by said non-compliance cannot be attributed to the manufacturer.**



**The manufacturer declines all liability for any inaccuracies in this booklet attributable to transcription errors or misprints. The manufacturer also reserves the right to make the modifications that it deems useful or necessary to the product, without compromising its essential characteristics.**

# DANGER ICONS



## DANGER OF BURNS AND INJURIES

While the oven is cooking and cooling down, pay attention to:

- Wear heat protective gloves and clothing.
- Touch only the controls or the oven handle or the part limited by the oven adhesive, since external parts are hot (temperature over 60°C).
- Use the utmost caution when opening the door since steam at high temperature is released.
- When inserted onto the rails, trays must be blocked.
- Pay the utmost attention when taking the trays out of the chamber.
- Do not open the oven door while washing to avoid injuries caused by the steam and chemicals used.



## DANGER OF FIRE

- Ensure the fume exhaust is free from obstructions and that there are no flammable materials nearby.
- Ensure no foreign objects (instruction manual, bags, gloves, etc.) or detergent residues have been left inside the oven.
- Do not bring flammable objects or substances (petrol, diesel, spirits, etc.) near the oven.
- Do not use food or liquids that can easily ignite while cooking.

The cooking chamber must always be clean. If not removed, oil or fat can ignite at high temperatures.



## DANGER OF ELECTRIC SHOCK

- Opening the compartments marked with this symbol is reserved only to YESOVENS qualified staff; non-compliance with this provision will make the warranty null and void.
- Do not touch any electrical switch so as not to cause any sparks or flames.
- Keep the fume exhaust pipe free from obstructions at all times.
- If present, turn the fume extraction hood on while using the oven.
- The oven must be installed far from drafts or wind.
- Ensure the oven vents are clean and unobstructed.

# Technical Data Sheet EGO 6/7T

**YESOVENS**  
CONTEMPORARY AIR

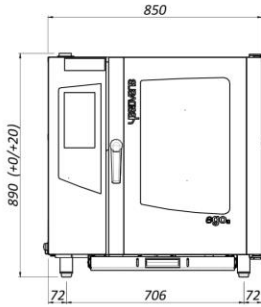

Front

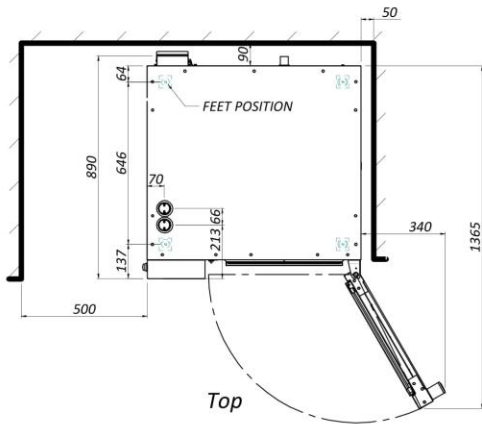

Top

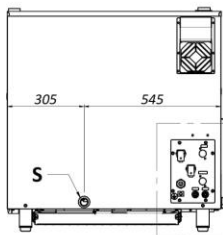

Back

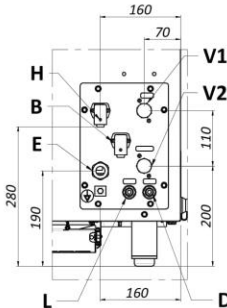

- C: Steam outlet chimney / Air inlet chimney
- V1: Washing solenoid valve
- V2: Steam solenoid valve
- H: Hood connection
- E: Electric connection
- S: Drain water
- B: Detergent level connection
- L: Limescale entry
- D: Detergent entry

## Dimensions and weight

Oven width: 850mm  
Oven depth: 890mm  
Oven height: 890mm  
Net weight full optional: 105 kg

Packaging width: 915 mm  
Packaging depth: 1000 mm  
Packaging height: 1045 mm  
Weight with packaging full optional: 123 kg  
Packaging volume: 0.95 m<sup>3</sup>

## Installation

Minimum left side distance: 500 mm  
Minimum right side distance: 50 mm  
Minimum back distance: 50 mm  
Min. distance from heat sources: 500 mm

## Electrical connection

Supply: 380-415 V 3N 50/60 Hz  
230 V 3P 50/60 Hz

Max power: 18 kW

Current: 30 A  
50 A

Cable: 5x4 mm<sup>2</sup>  
H07RN-F

## Water connection

Water wash connection V1: 3/4"  
Steam water connection V2: 3/4" softened  
Water pressure: 1.5-5 bar  
Water hardness: 4° d  
Minimum Conductance: 50 µS/cm  
Exhaust size S: 1"

## Capacity

Trays type: GN11  
Number of trays: 6  
7  
Distance between trays: 80 mm  
70 mm  
Max load: 35 kg  
Max load single tray: 5 kg

IP rating: IPx4



# Technical Data Sheet EGO 10/11T

**YESOVENS**  
CONTEMPORARY AIR

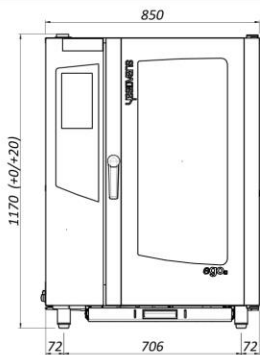

Front

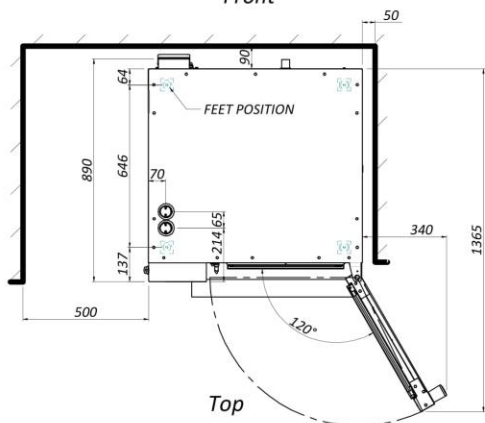

Top

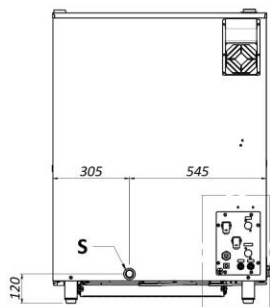

Back

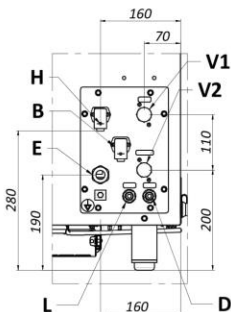

- C: Steam outlet chimney / Air inlet chimney
- V1: Washing solenoid valve
- V2: Steam solenoid valve
- H: Hood connection
- E: Electric connection
- S: Drain water
- B: Detergent level connection
- L: Limescale entry
- D: Detergent entry

## Dimensions and weight

Oven width: 850 mm  
Oven depth: 890 mm  
Oven height: 1170 mm  
Net Weight full optional: 142 kg

Packaging width: 915 mm  
Packaging depth: 1000 mm  
Packaging height: 1330 mm  
Weight with packaging full optional: 162 kg  
Packaging volume: 1.21 m<sup>3</sup>

## Installation

Minimum left side distance: 500 mm  
Minimum right side distance: 50 mm  
Minimum back distance: 50 mm  
Min. distance from heat sources: 500 mm

## Electrical connection

Supply: 380-415 V 3N 50/60 Hz  
230 V 3P 50/60/ Hz

Max power: 24 kW

Current: 40 A  
70 A

Cable: 5x4mm<sup>2</sup>  
H07RN-F

## Water connection

Water wash connection V1: 3/4"  
Steam water connection V2: 3/4" softened  
Water pressure: 1.5-5 bar  
Water hardness: 4° d  
Minimum Conductance: 50 µS/cm  
Exhaust size S: 1"

## Capacity

Trays type: GN11  
Number of trays: 10  
11  
Distance between trays: 80 mm  
70 mm  
Max load: 45 kg  
Max load single tray: 5 kg

IP rating: IPx4

# Technical Data Sheet EGO TROLLEY OVENS

**vestivens**  
CONTEMPORARY aRT

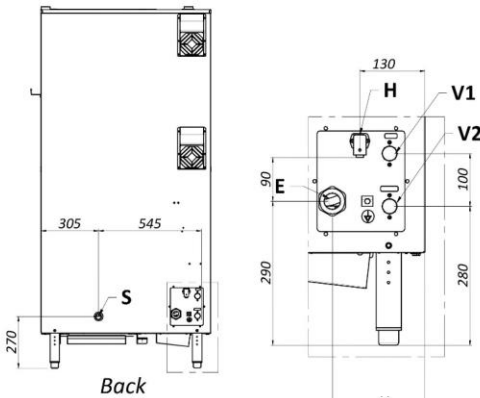
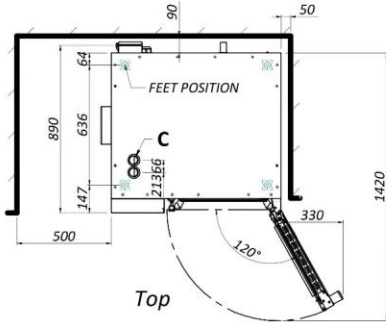
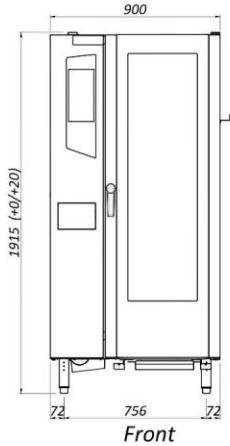

**C:** Steam outlet chimney / Air inlet chimney  
**V1:** Washing solenoid valve  
**V2:** Steam solenoid valve  
**H:** Hood connection  
**E:** Electric connection  
**S:** Drain water

## Dimensions and weight

Oven width: 900 mm  
Oven depth: 890 mm  
Oven height: 1915 mm  
Net weight full optional: 225 Kg

Packaging width: 980 mm  
Packaging depth: 1010 mm  
Packaging height: 2095 mm  
Weight with packaging full optional: 265 Kg  
Packaging volume: 2.07 m<sup>3</sup>

## Installation

Minimum left side distance: 500 mm  
Minimum right side distance: 50 mm  
Minimum back distance: 50 mm  
Min. distance from heat sources: 500 mm

## Electrical connection

Supply: 380-415 V 3N 50/60 Hz

Maximum power: 39 kW

Current: 64 A

Cable dimension: 5x10mm<sup>2</sup>  
H07RN-F

## Water connection

Water wash connection V1: 3/4"  
Steam water connection V2: 3/4" Softened  
Water pressure: 1.5-5 bar  
Max water hardness: 4° d  
Minimum Conductance: 50 µS/cm  
Exhaust size S: 1"

IP rating: IPx4

# Technical Data Sheet GN11 TROLLEY

**yes**ovens  
CONTEMPORARY ART

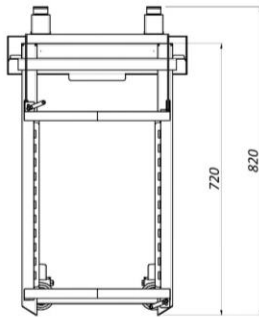
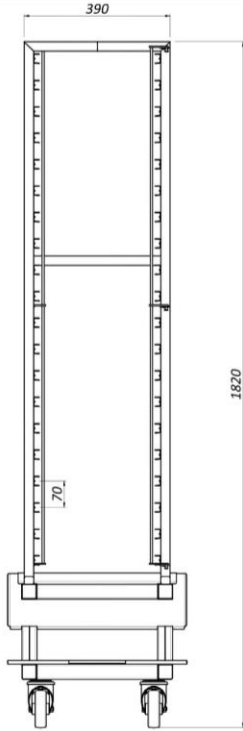

Capacity trolley

Trays type: GN11  
Number of trays: 20  
Distance between trays: 70 mm  
Weight Trolley: 37Kg  
Max load: 90Kg

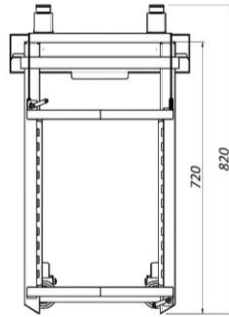
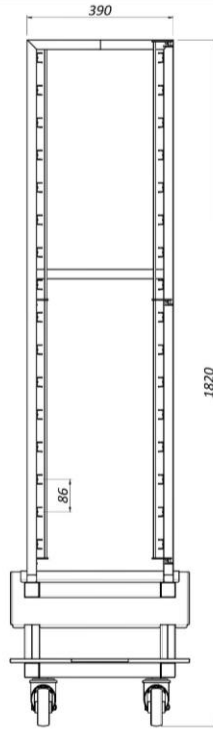

Capacity trolley

Trays type: GN11  
Number of trays: 16  
Distance between trays: 85 mm  
Weight Trolley: 35Kg  
Max load: 90Kg

# Technical Data Sheet EGO TROLLEY OVENS 16T

**yesovens**  
CONTEMPORARY ART

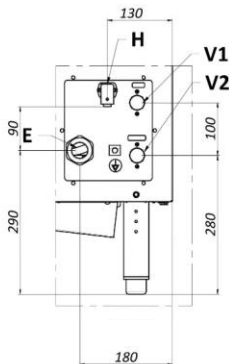
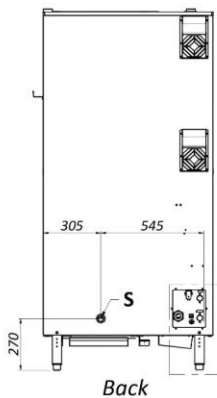
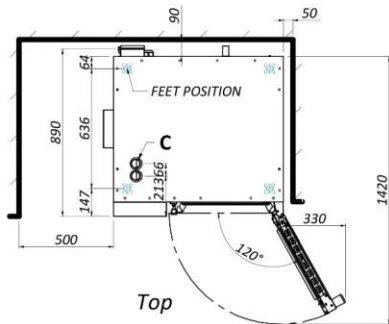
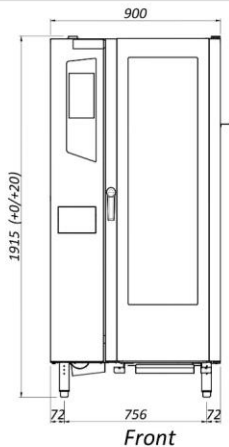

C: Steam outlet chimney / Air inlet chimney  
V1: Washing solenoid valve  
V2: Steam solenoid valve  
H: Hood connection  
E: Electric connection  
S: Drain water

## Dimensions and weight

Oven width: 900 mm  
Oven depth: 890 mm  
Oven height: 1915 mm  
Net weight full optional: 220 Kg

Packaging width: 980 mm  
Packaging depth: 1010 mm  
Packaging height: 2095 mm  
Weight with packaging full optional: 260 Kg  
Packaging volume: 2.07 m<sup>3</sup>

## Installation

Minimum left side distance: 500 mm  
Minimum right side distance: 50 mm  
Minimum back distance: 50 mm  
Min. distance from heat sources: 500 mm

## Electrical connection

Supply: 380-415 V 3N 50/60 Hz  
Max power: 31.5 kW  
Current: 53 A  
Cable: 5x10mm<sup>2</sup>  
H07RN-F

## Water connection

Water wash connection V1: 3/4"  
Steam water connection V2: 3/4" Softened  
Water pressure: 1.5-5 bar  
Max water hardness: 4° d  
Minimum Condutance: 50 µS/cm  
Exhaust size S: 1"

IP rating: IPx4

# Technical Data Sheet EGO 16T TROLLEY 6040

**yes** **stevens**  
CONTEMPORARY art

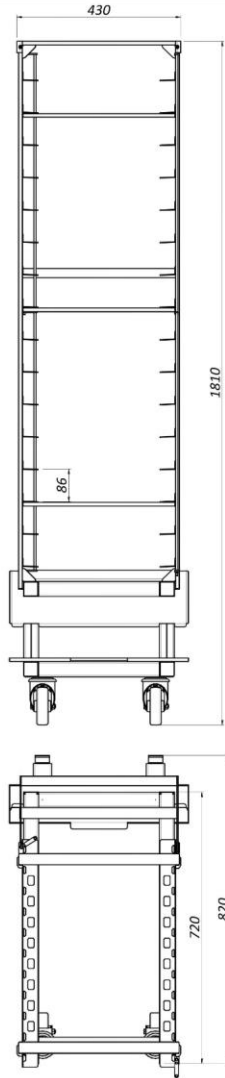

## Capacity trolley

**Trays type:** 6040  
**Number of trays:** 16  
**Distance between trays:** 85 mm  
**Weight Trolley:** 35Kg  
**Max load:** 90Kg

# Technical Data Sheet Slim 6T

**yesovens**  
CONTEMPORARY ART

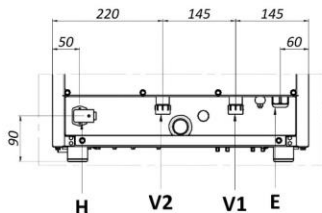
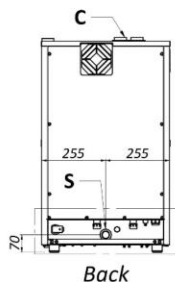
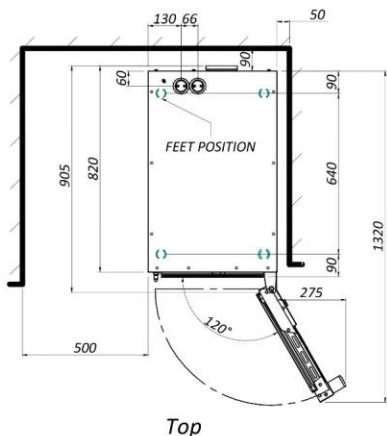

- C: Steam outlet chimney / Air inlet chimney
- V1: Washing solenoid valve
- V2: Steam solenoid valve
- H: Hood connection
- E: Electric connection
- S: Drain water

## Dimensions and weight

Oven width: 510 mm  
Oven depth: 905 mm  
Oven height: 850 mm  
Net weight full optional: 79 kg

Packaging width: 590 mm  
Packaging depth: 980 mm  
Packaging height: 1000 mm  
weight with packaging full optional: 91 kg  
Packaging volume: 0.58 m<sup>3</sup>

## Installation

Minimum left side distance: 500 mm  
Minimum right side distance: 50 mm  
Minimum back distance: 50 mm  
Min. distance from heat sources: 500 mm

## Electrical connection

Supply: 380-415 V 3N 50/60 Hz  
230 V 3P 50/60 Hz

Max power: 7.5 kW

Current: 14 A  
24 A

Cable: 5x4mm<sup>2</sup>  
H07RN-F

## Water connection

Water wash connection V1: 3/4"  
Steam water connection V2: 3/4" softened  
Water pressure: 1.5-5 bar  
Water hardness: 4° d  
Minimum Conductance: 50 µS/cm  
Exhaust size S: 1"

## Capacity

Trays type: GN11  
Number of trays: 6  
Distance between trays: 70 mm  
Max load: 30 kg  
Max load single tray: 5 kg

IP rating: IPx4

393900091 TECHNICAL\_DATA\_SHEET\_SLIM\_6T

# Technical Data Sheet Slim 6T Steamer

**yesovens**  
CONTEMPORARY ART

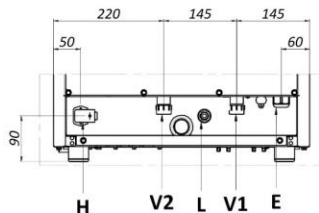
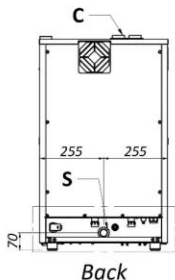
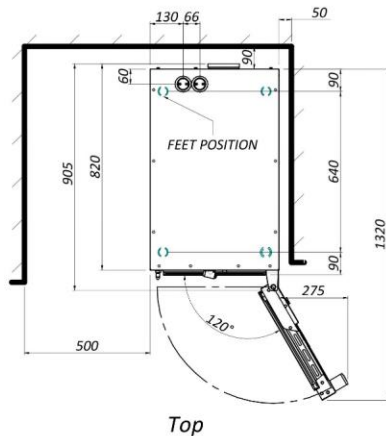
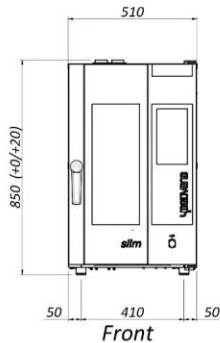

- C: Steam outlet chimney / Air inlet chimney
- V1: Washing solenoid valve
- V2: Steam solenoid valve
- H: Hood connection
- E: Electric connection
- S: Drain water
- L: Limescale entry

## Dimensions and weight

Oven width: 510 mm  
Oven depth: 905 mm  
Oven height: 850 mm  
Net weight full optional: 83 kg

Packaging width: 590 mm  
Packaging depth: 980 mm  
Packaging height: 1000 mm  
Weight with packaging full optional: 95 kg  
Packaging volume: 0.58 m<sup>3</sup>

## Installation

Minimum left side distance: 500 mm  
Minimum right side distance: 50 mm  
Minimum back distance: 50 mm  
Min. distance from heat sources: 500 mm

## Electrical connection

Supply: 380-415 V 3N 50/60 Hz  
230 V 3P 50/60 Hz

Max power: 10.5 kW

Current: 17 A  
30 A

Cable dimension: 5x4mm<sup>2</sup>  
H07RN-F

## Water connection

Water wash connection V1: 3/4"  
Steam water connection V2: 3/4" softened  
Water pressure: 1.5-5 bar  
Water hardness: 4° d  
Minimum Conducance: 50 µS/cm  
Exhaust size S: 1"

## Capacity

Trays type: GN11  
Number of trays: 6  
Distance between trays: 70 mm  
Max load: 30 kg  
Max load single tray: 5 kg

IP rating: IPx4

393900090 TECHNICAL\_DATA\_SHEET\_SLIM\_6T\_STEAMER

YESOVENS SRL

Via dell'industria 1 - 35010 Borgoricco (PD) Italy - T.+39 0499336455 - F. +39 049 9335611 - info@yesovens.it - www.yesovens.it

# Technical Data Sheet STAR 6T

**yesovens**  
CONTEMPORARY airT

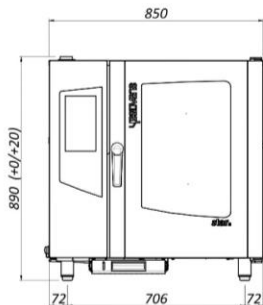

Front

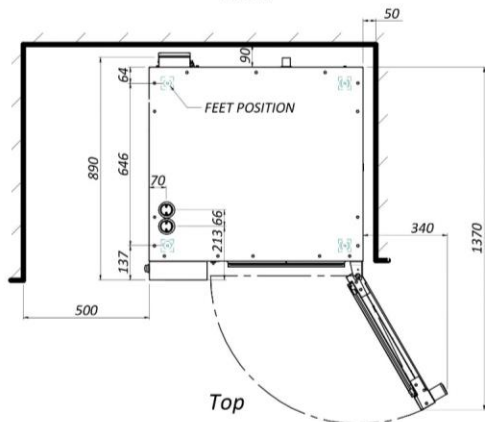

Top

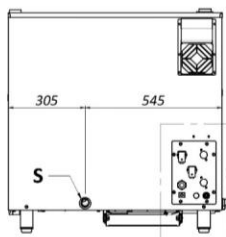

Back

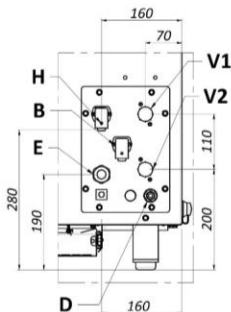

- C: Steam outlet chimney / Air inlet chimney
- V1: Washing solenoid valve
- V2: Steam solenoid valve
- H: Hood connection
- E: Electric connection
- S: Drain water
- B: Detergent level connection
- D: Detergent entry

## Dimensions and weight

Oven width: 850mm  
Oven depth: 890mm  
Oven height: 890mm  
Net weight full optional: 95 kg

Packaging width: 915 mm  
Packaging depth: 1000 mm  
Packaging height: 1045 mm  
Weight with packaging full optional: 113 kg  
Packaging volume: 0.95 m<sup>3</sup>

## Installation

Minimum left side distance: 500 mm  
Minimum right side distance: 50 mm  
Minimum back distance: 50 mm  
Min. distance from heat sources: 500 mm

## Electrical connection

Supply: 380-415 V 3N 50/60 Hz  
230 V 3P 50/60 Hz  
230 V 1N 50/60 Hz

Max power: 11 kW

Current: 18 A  
32 A  
48 A

Cable: 5x4mm<sup>2</sup>  
H07RN-F

## Water connection

Water wash connection V1: 3/4"  
Steam water connection V2: 3/4" softened  
Water pressure: 1.5-5 bar  
Water hardness: 4° d  
Minimum Conductance: 50 µS/cm  
Exhaust size S: 1"

## Capacity

Trays type: 6040  
Number of trays: 6  
Distance between trays: 80 mm  
Max load: 30 kg  
Max load single tray: 5 kg

IP rating: IPx4

39390092 TECHNICAL\_DATA\_SHEET\_STAR\_6T\_G19



# Technical Data Sheet STAR 10T

**yesovens**  
CONTEMPORARY aIRT

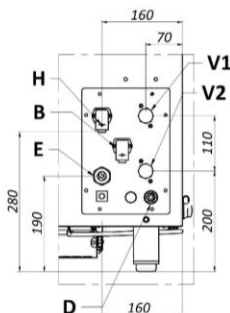
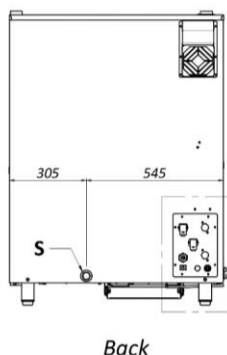
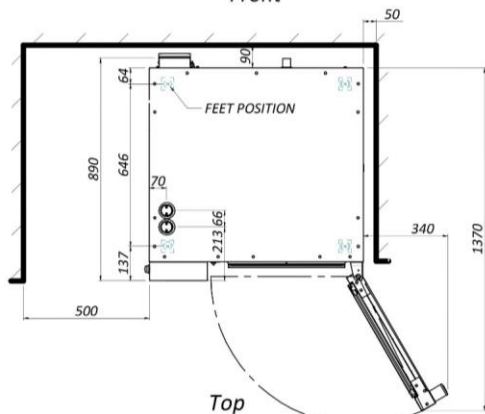
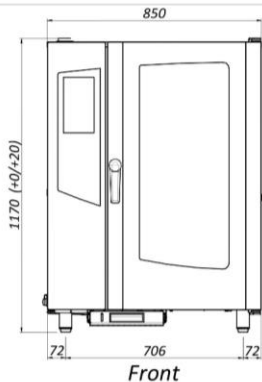

- C: Steam outlet chimney / Air inlet chimney
- V1: Washing solenoid valve
- V2: Steam solenoid valve
- H: Hood connection
- E: Electric connection
- S: Drain water
- B: Detergent level connection
- D: Detergent entry

## Dimensions and weight

Oven width: 850mm  
Oven depth: 890mm  
Oven height: 1170mm  
Net weight full optional: 132 kg

Packaging width: 915 mm  
Packaging depth: 1000 mm  
Packaging height: 1330 mm  
Weigh with packaging full optional: 152 kg  
Packaging volume: 1.22 m<sup>3</sup>

## Installation

Minimum left side distance: 500 mm  
Minimum right side distance: 50 mm  
Minimum back distance: 50 mm  
Min. distance from heat sources: 500 mm

## Electrical connection

Supply: 380-415 V 3N 50/60 Hz  
230 V 3P 50/60 Hz

Max power: 17 kW

Current: 29 A  
50 A

Cable: 5x4mm<sup>2</sup>  
H07RN-F

## Water connection

Water wash connection V1: 3/4"  
Steam water connection V2: 3/4" softened  
Water pressure: 1.5-5 bar  
Water hardness: 4° d  
Minimum Conductance: 50 µS/cm  
Exhaust size S: 1"

## Capacity

Trays type: 6040  
Number of trays: 10  
Distance between trays: 80 mm  
Max load: 35 kg  
Max load single tray: 5 kg

IP rating: IPx4

393900093 TECHNICAL\_DATA\_SHEET\_STAR\_10T\_G19

# HANDLING, TRANSPORT AND UNLOADING

The oven is packed by the company according to signed agreements on a case by case basis, or in any case according to the country of destination or means of transport used.

After installation, all packaging can be recycled or disposed of in compliance with the regulations in force in the buyer's country.



Ovens must be transported near the installation site complete with their packaging. Specialised staff must be appointed to perform all operations involving the lifting and handling of the oven or its separately transported parts. The shipped material is carefully checked before being delivered to the carrier.

On receipt of the oven, check that it has not been damaged during transport, that the packaging has not been tampered with and that no internal parts have been removed.

If there is found to be damage or missing parts, immediately inform both the carrier and the manufacturer and provide photographic evidence.



Please check that the supply matches the order specifications. **The oven must not be dragged or tilted under any circumstances. The oven must be lifted perpendicular to the floor, moved horizontally and placed vertically on the floor.**

The oven is supplied on a pallet, kept in place by plastic strapping bands and protected by cardboard packaging. Loading/Unloading the oven onto/from the transport vehicle is normally done using a forklift truck or trolley.



Indoor handling must take place with all the necessary precautions so that the oven components are not damaged.

Loading and unloading into/from the transport vehicle can be carried out:

- Using a forklift truck.
- All precautions aimed at preventing the oven from being damaged must be adopted during the transport.
- While handling, pay particular attention not to hit the "surroundings" such as columns, walls, other machinery, etc.
- In particular, the oven must not be placed on top of other materials, or other materials on top of the oven, either during transport or storage.
- During transport, the oven must be placed in such a way as not to be hit by other materials loaded on the same vehicle.
- Before unloading it from the transport vehicle, check that the packaging is undamaged and that there is no risk of it tipping over.
- While unloading, place the oven on the ground cautiously, to avoid damaging shocks.

**The installation, transformation and maintenance of the equipment must be carried out by authorized fitters or the electricity supplier in compliance with the safety regulations in force.**



On receipt of the oven, check that it has not been damaged during transport, that the packaging has not been tampered with and that no internal parts have been removed. If damage or missing parts are found, immediately inform both the carrier and the manufacturer, providing photographic evidence. It is recommended to check that the supply matches the order specifications.

# UNPACKING THE OVEN

## PAY ATTENTION !

When you are handling packaging, you must take into account the symbols printed on the packaging itself. The protection of the environment is an obligation explicitly laid down in the laws and regulations in force.

All possible precautions must be taken when handling and/or transporting the oven to avoid or limit any damage to property or injury to animals and, above all, people.

- Cut the plastic straps holding the cardboard packaging in place.(pic\_1)
- Remove the cardboard.(pic\_2)
- Remove the Styrofoam corners and top.(pic\_3)
- **Remove the pallet from the oven without using lifting trucks; the lower structure of the oven is not suitable to lift it.**
- Remove the protective film from the metal parts. Slowly remove the protective film from the oven. Any glue residue must be removed using appropriate solvents and without any tools that might scratch or damage the surfaces.

After removing all packaging from the oven, check its integrity and condition; then separate all the packaging materials (wood, plastic, cardboard) and place appropriate collection sites, accessible to authorized people only, waiting for collection by specialized companies. Packaging materials must be kept out of reach of children or animals.

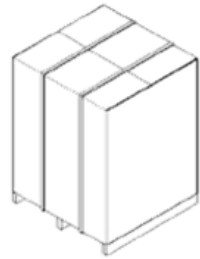

Pic\_1

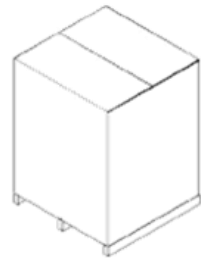

Pic\_2

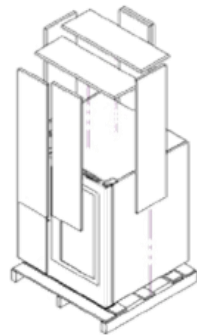

Pic\_3



Pic\_4

# UNPACKING THE RACK OVENS

## PAY ATTENTION !

When you are handling packaging, you must take into account the symbols printed on the packaging itself. The protection of the environment is an obligation explicitly laid down in the laws and regulations in force.

All possible precautions must be taken when handling and/or transporting the oven to avoid or limit any damage to property or injury to animals and, above all, people.

- Cut the plastic straps holding the cardboard packaging in place.(pic\_1)
- Remove the cardboard.(pic\_1)
- Remove the Styrofoam corners and top.(pic\_1)
- **Remove trolley from the oven and after, remove pallet.(pic\_2) (pic\_3)**
- Remove the protective film from the metal parts. Slowly remove the protective film from the oven. Any glue residue must be removed using appropriate solvents and without any tools that might scratch or damage the surfaces.

After removing all packaging from the oven, check its integrity and condition; then separate all the packaging materials (wood, plastic, cardboard) and place appropriate collection sites, accessible to authorized people only, waiting for collection by specialized companies. Packaging materials must be kept out of reach of children or animals.

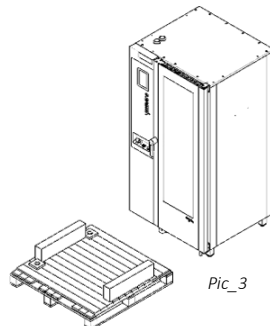
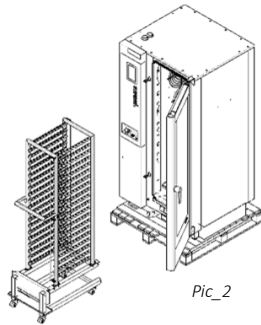
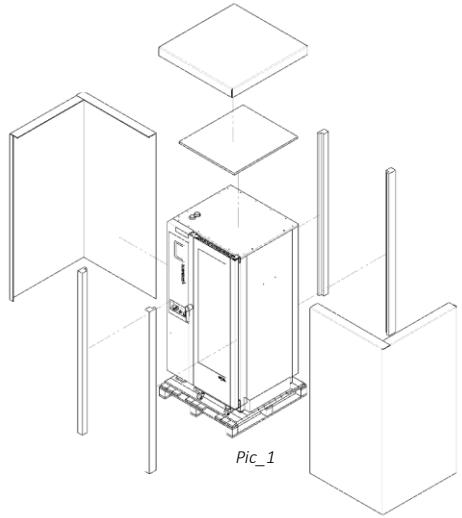

# INSTALLATION INSTRUCTIONS

## INSTALLATION SITE AND POSITIONING

The oven installation as well as its routine and corrective maintenance must be carried out by authorised fitters only or in any case by qualified personnel in compliance with current safety and/or local regulations.

Ensure a distance of at least 30 cm from the ceiling if this is made of combustible materials or if it is not thermally insulated.

In the event the oven is positioned in the immediate vicinity of a flammable wall, suitable thermal insulation must be provided.

Openings and grooves on the external part of the oven must not be obstructed as these are necessary to disperse the heat in the electrical compartment.

Once the equipment has been installed, the electrical cable must be protected and must never be dragged or pulled.

Leave 500mm clearance to the left side for inspection purposes in case of failure, and not less than 50mm (300mm for rack ovens) at the rear side.

Do not obstruct or narrow the oven exhaust to avoid malfunctions.

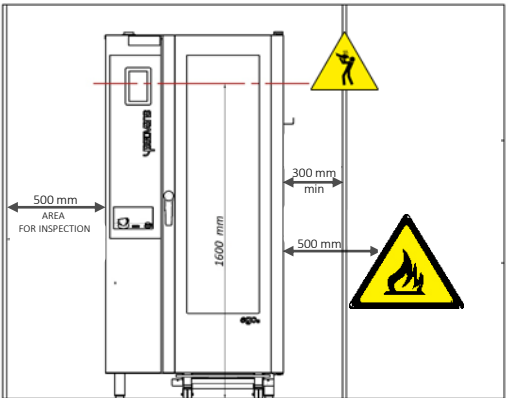
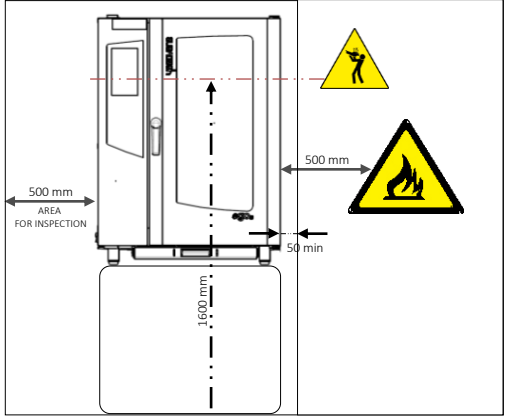

In case the oven is installed on a support, make sure the height of the highest tray does not exceed 1600mm from the ground; if so, add the adhesive supplied in the packaging with the tray.

## POSITIONING THE OVENS

For the proper operation of the oven, the work station must be perfectly flat and levelled.

The working surface has to be:

- perfectly levelled;
- flat;
- it has to bear the weight of the oven with no deformation whatsoever;
- it must not be flammable or heat-sensitive.

The oven has to be positioned perfectly levelled by adjusting the feet provided on the lower rounded side.

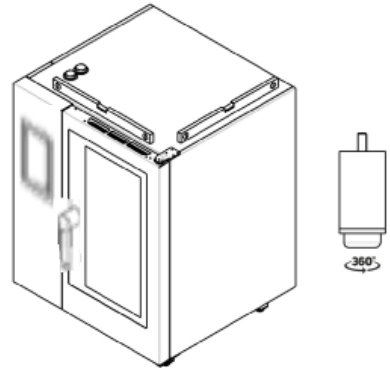

## POSITIONING THE RACK OVENS

For the proper operation of the oven, the work station must be perfectly flat and levelled.

The working surface has to be:

- perfectly levelled;
- flat;
- it has to bear the weight of the oven with no deformation whatsoever;
- it must not be flammable or heat-sensitive.

The oven has to be positioned perfectly levelled by adjusting the feet provided on the lower rounded side.

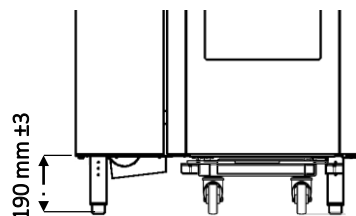
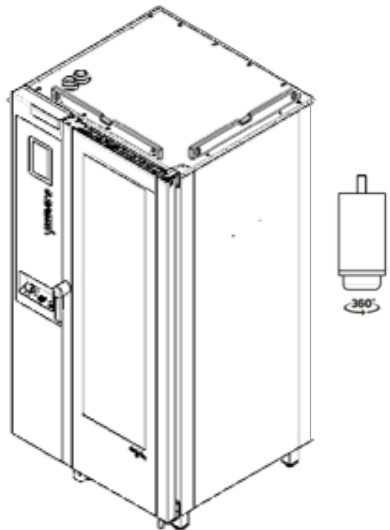

## CONNECTIONS SCHEME



The room where the oven is to be installed must be provided with power, water and gas connections compliant with the regulations regarding the systems and safety at work of the country where it is to be used.

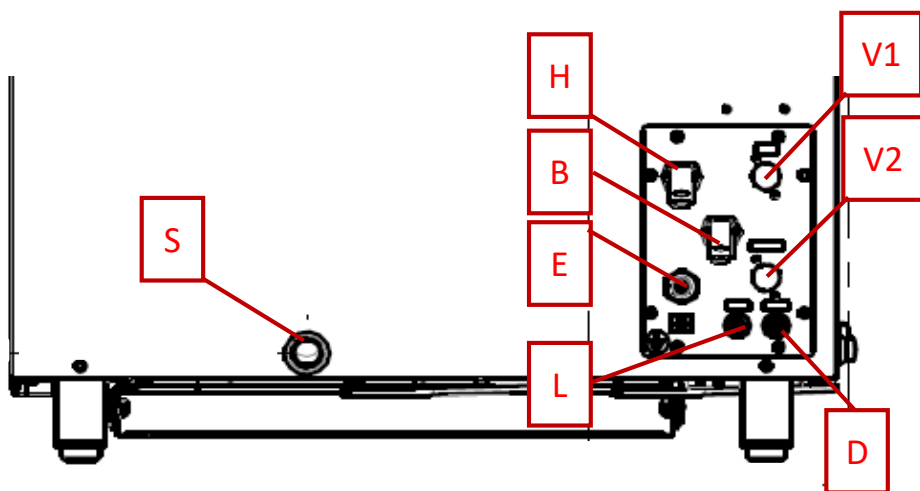

- V1:** Washing solenoid valve
- V2:** Steam solenoid valve
- H:** Hood connection
- E:** Electric connection
- S:** Drain water
- B:** Detergent level connection
- L:** Limescale entry
- D:** Detergent entry



## CONNECTIONS SCHEME SLIM OVEN



The room where the oven is to be installed must be provided with power, water and gas connections compliant with the regulations regarding the systems and safety at work of the country where it is to be used.

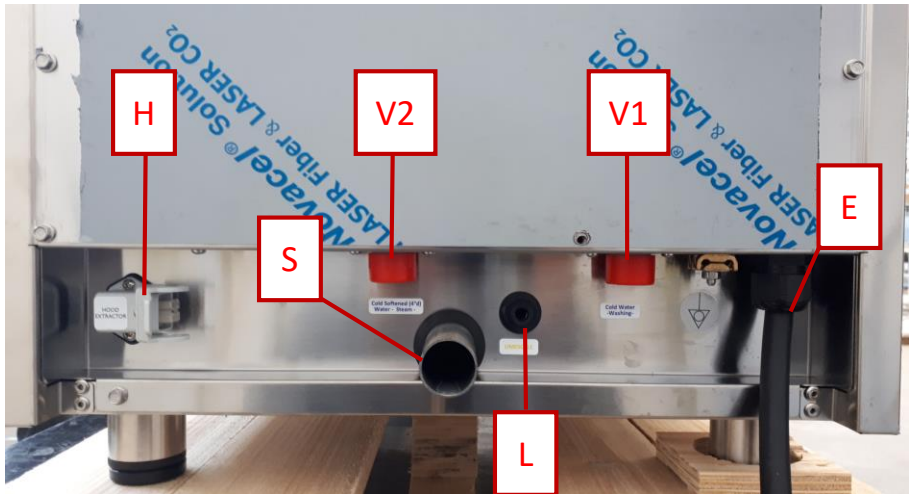

- V1:** Washing solenoid valve
- V2:** Steam solenoid valve
- H:** Hood connection
- E:** Electric connection
- S:** Drain water
  
- L:** Limescale entry

## CONNECTIONS SCHEME RACK – TROLLEY OVEN



The room where the oven is to be installed must be provided with power, water and gas connections compliant with the regulations regarding the systems and safety at work of the country where it is to be used.

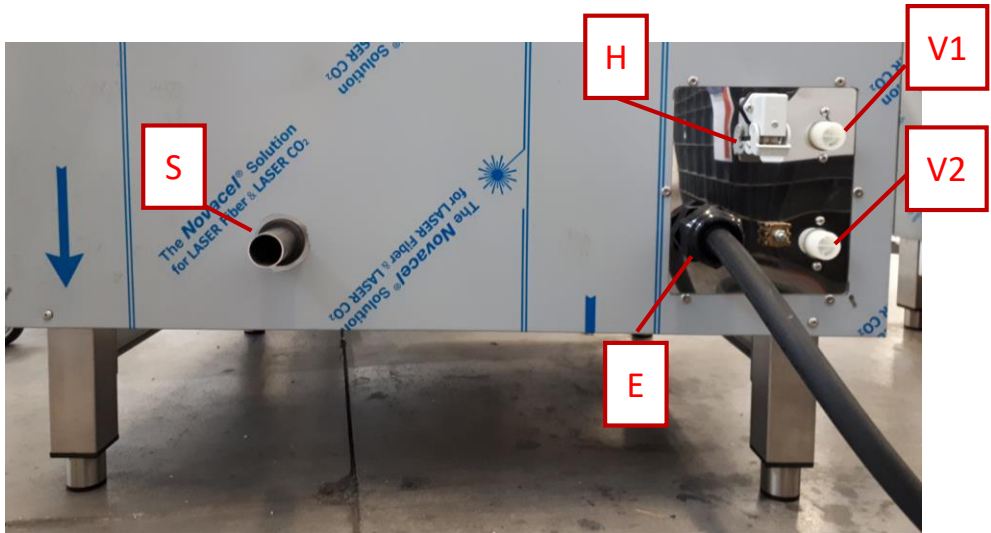

- V1:** Washing solenoid valve
- V2:** Steam solenoid valve
- H:** Hood connection
- E:** Electric connection
- S:** Drain water



It is necessary to insert the supplied siphon before connecting the exhaust (S in the picture) to the water system.

## CONNECTION TO THE POWER SUPPLY

The connection to the power supply must be made according to current international, national and local regulations. Prior to making the connection, check that the voltage and frequency of the power network matches the values shown on the data plate positioned on the back of the oven.

**A variation of  $\pm 5\%$  on the power rated is allowed.**

The oven must be permanently connected to the power supply using a cable type of at least H07RN-F (in polychloroprene heavyweight rubber) or higher, making sure the wire gauge of the conductor wires is compatible with the maximum absorbed load. A unipolar general switch must be placed between the oven and the power supply network, with an opening of at least 3 mm between contacts, whose capacity is compatible with the load and fitted with suitable safety devices. Differential, high-sensitivity automatic safety devices must be provided so as to ensure protection against direct and indirect contact with live parts and ground-fault currents according to current regulations; the maximum allowed leakage current is 1 mA/kW. This switch must be installed as part of the installation site's permanent electrical system and in the immediate vicinity of the equipment in order to facilitate operator access. Refer to the table of technical data for information on the dimensions of the power line, general switch and cable.

Ovens are supplied with a H07RN-F cable.

To connect or replace the supply cable to the oven terminal board, proceed as follows:

- Connect the wires of the electrical cable to the terminal board on the back of the oven, as shown in the electrical diagram.
- Make sure the yellow/green earth wire is about 3 cm longer than the others (phase and neutral) so that if pulled, it will be the last one to detach, ensuring protection against any electric shocks.
- Block the cable into place and close the terminal board cover.



## EARTHING

The oven must be connected to an efficient grounding system. The yellow/green wire of the supply cable must be connected to the terminal marked with the earth symbol.

The oven must be included in an equipotential system and connected with a conductor having a minimum wire gauge of 10 mm<sup>2</sup>, connected to the terminal located on the back of the oven bearing the appropriate symbol.

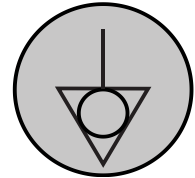

## CONNECTION TO THE WATER SUPPLY

- Connect the 3/4" fittings of the oven to the water supply pipe; to use a filtering system is strictly recommended.
- For greater effectiveness of the steam components and considering that water goes inside during cooking it is **mandatory to provide a filtering system to optimize and soften the water** (YESOVENS ACCESSORY).

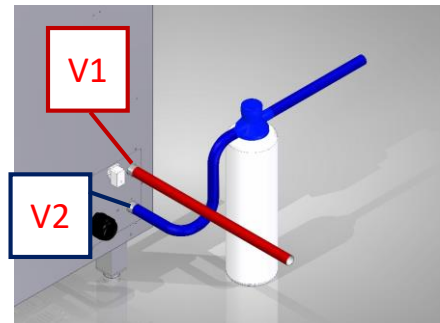

**V1:** Washing solenoid valve  
**V2:** Steam solenoid valve

- The allowed supplied pressure is 1,5 bar minimum, 5 bar maximum.
- The tube connected to the outlet must not have narrowed section and it must not be blocked.

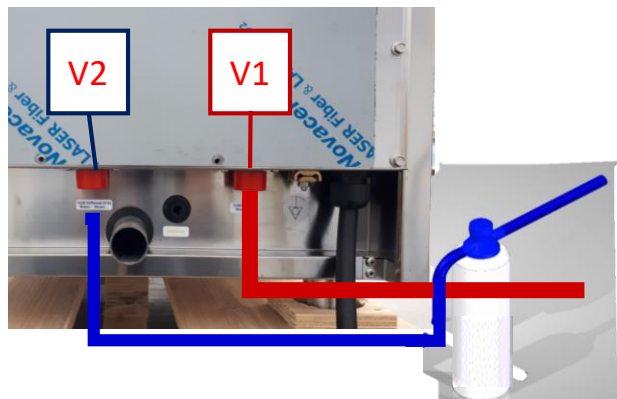

## NOTE FOR RACK OVENS

- It is necessary to insert the supplied siphon before connecting the exhaust to the water system.

## DOOR SETTING

After the oven installation is needful to check that the inner glass correctly seal to the gasket. During the transport of the device, especially in the case of long journeys, the door could lose part of the adjustment carried out during the testing phase.

- Check is possible by starting a rinse (that can be stopped or paused every time you want) and watching if there is water leaking.
- In the absence of water or the automatic washing system, the control can be performed by placing a thin tape of paper between the gasket and the glass (see photo 1 and 2). Place the tape in several positions to ensure that the gasket adheres completely. If the tape runs smoothly, it means that the inner glass needs better adjustment.

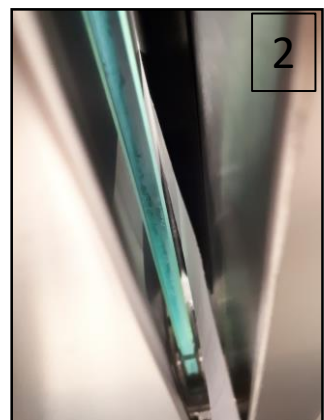

- In the absence of water or the automatic washing system, the control can be performed by placing a thin tape of paper between the gasket and the glass (see photo 1 and 2). Place the tape in several positions to ensure that the gasket adheres completely. If the tape runs smoothly, it means that the inner glass needs better adjustment.



- Once understood the points where it is necessary to make the glass adhere more to the gasket, make the adjustment by placing an appropriate number of shims under the hinges of the inner glass (photos 3 and 4) and / or screwing the door pin (picture 5) until it is necessary.



# INSTRUCTIONS FOR USE

## PRELIMINARY WARNINGS

- The equipment is for professional use only and must be used by trained personnel.
- The oven must be used only to cook food, any other use shall be considered inappropriate.



- **It is absolutely prohibited to wash the cooking chamber or the glass door with jets of cold water when their temperature is still greater than 70°C.**
- Installation and all corrective maintenance must be carried out by authorised personnel with the necessary professional requirements.
- It is recommended to have the oven checked at regular intervals. As to repairs, please contact only authorised Service Centres and request that they use original spare parts.
- In case of a fault or malfunction, disconnect the main power switch and turn off the water supply taps located upstream of the equipment. For all repairs, contact the authorised Service Centres. The end user is only responsible for oven's routine maintenance that is to check oven's efficiency and ensure its daily cleaning. Always keep the steamer, if present, clean by doing periodic specific washing to avoid scale build-up and malfunctions. Wash the steamer after every 10 hours of steamer work
- **Non-compliance with these obligations will release the manufacturer from any responsibility.**
- Read this booklet carefully since it contains important information and instructions about installation, use and maintenance safety. Keep it safe for future consultation.
- Before starting the oven, clean all surfaces that may come into contact with food.



The areas marked with the following symbol reach high temperatures. Take care and wear protective gloves if necessary.



## SAFETY DEVICES

**A: Safety thermostat:** if the cooking chamber overheats, it cuts off the heating to the chamber. The safety thermostat can be manually reset only by pressing the button on the bottom behind the dashboard of the oven. Before proceeding make sure the power supply has been disconnected.

**B: Door micro switch** that stops the oven operating when the door is opened: both the heating system and cell ventilation motor are deactivated.

All the moving parts of the cooking chamber have protection grilles preventing access.

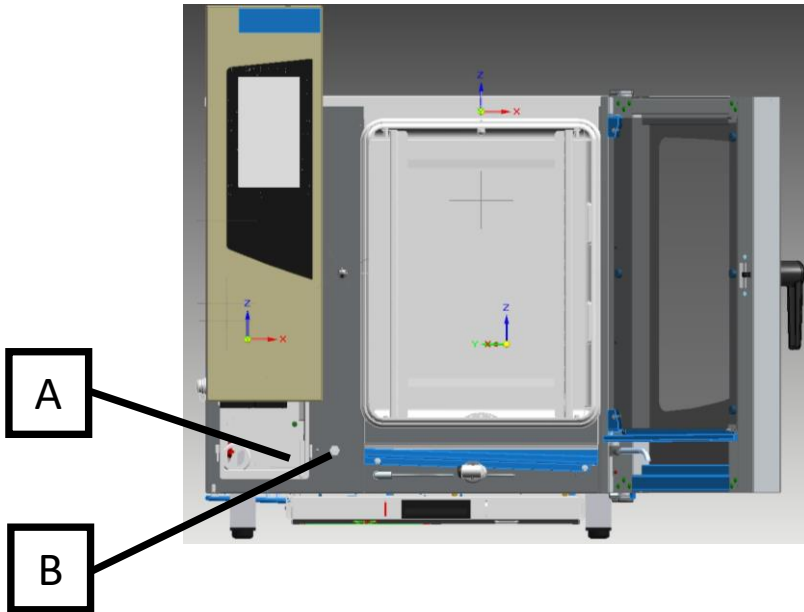

Any resetting must be carried out by specialised technical personnel after the causes of the disruption have been eliminated.

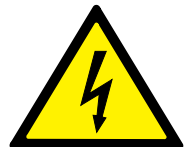



## SAFETY DEVICES SLIM OVEN

**A: Safety thermostat:** if the cooking chamber overheats, it cuts off the heating to the chamber. The safety thermostat can be manually reset only by pressing the button on the top of the oven by removing the roof or the rear panel. Before proceeding make sure the power supply has been disconnected.

**B: Door micro switch** that stops the oven operating when the door is opened: both the heating system and cell ventilation motor are deactivated.

All the moving parts of the cooking chamber have protection grilles preventing access.

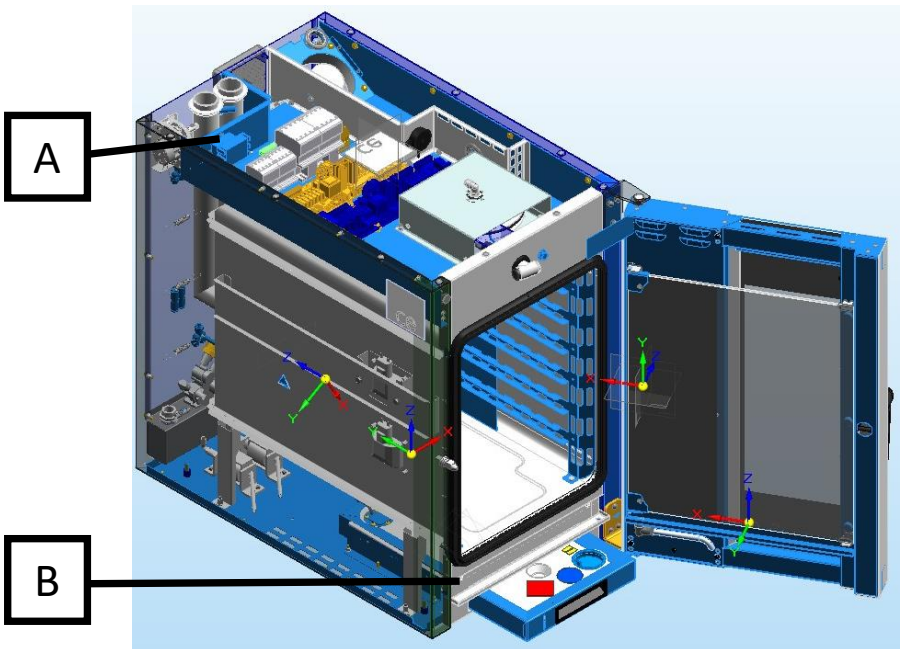

Any resetting must be carried out by specialised technical personnel after the causes of the disruption have been eliminated.



## SAFETY DEVICES RACK – TROLLEY OVENS

**A: Safety thermostat:** if the cooking chamber overheats, it cuts off the heating to the chamber. The safety thermostat can be manually reset only by pressing the button on the bottom behind the dashboard of the oven. Before proceeding make sure the power supply has been disconnected.

**B: Door micro switch** that stops the oven operating when the door is opened: both the heating system and cell ventilation motor are deactivated.

All the moving parts of the cooking chamber have protection grilles preventing access.

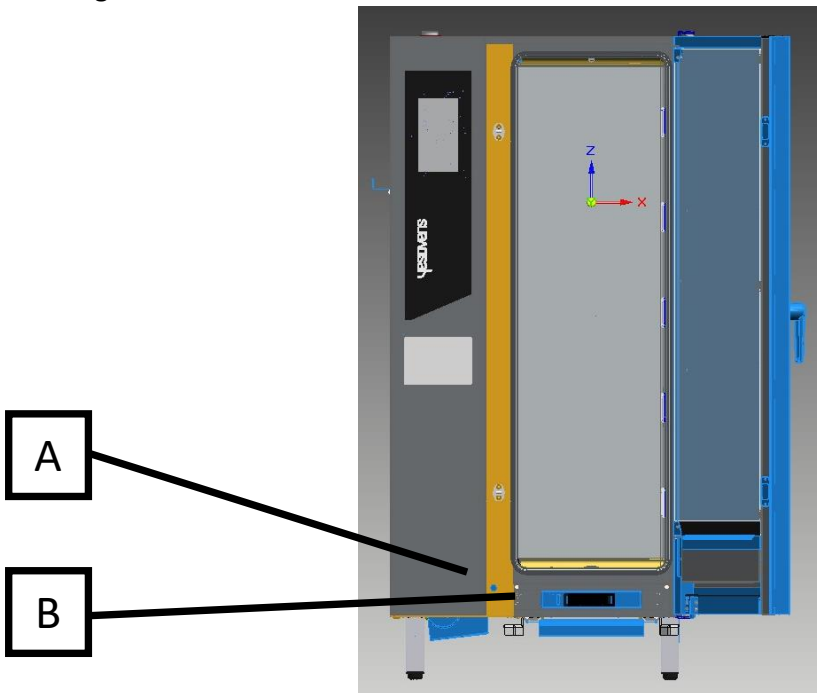

Any resetting must be carried out by specialised technical personnel after the causes of the disruption have been eliminated.



## DOOR OPENING AND CLOSING STANDARD HOOK

The equipment is for professional use only and must be used by trained personnel.

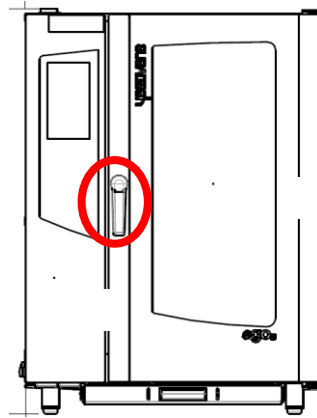

Handle position (*pic\_1*).

Move the handle on the different stage for open the door; to close the door simply push.

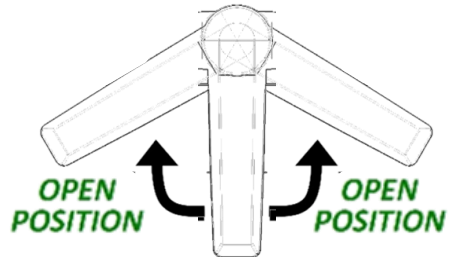

**CLOSE POSITION**

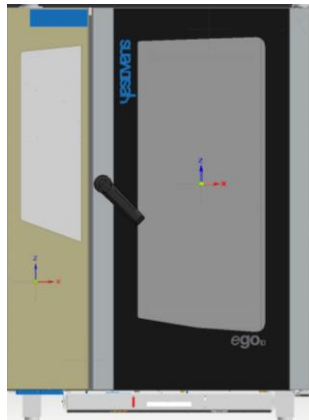

**OPEN POSITION**

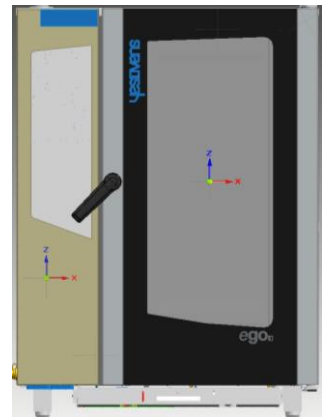

**OPEN POSITION**

## DOOR OPENING AND CLOSING TWO POSITIONS HOOK

The equipment is for professional use only and must be used by trained personnel.

Move the handle on the different stage for open the door, close the door or if you need to remove the hot humidity on safety (STEAM EXHAUST POSITION).  
(pic\_2)

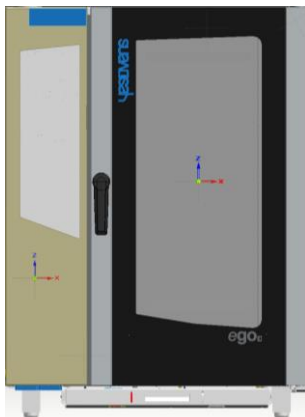
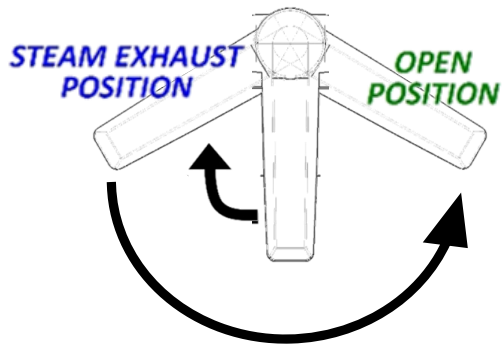

**CLOSE  
POSITION**

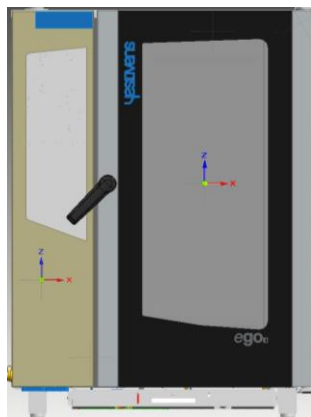

**STEAM EXHAUST  
POSITION**

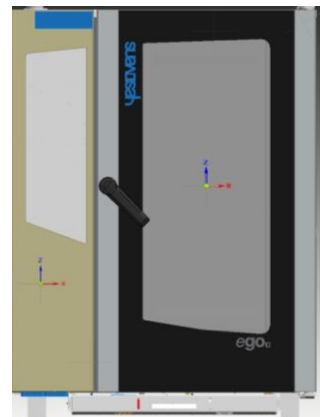

**OPEN  
POSITION**

## DOOR OPENING AND CLOSING FOR RACK – TROLLEY OVENS

The equipment is for professional use only and must be used by trained personnel.

Handle position (*pic\_1*).



*Pic\_1*

Move the handle on the different stage according the picture 2 for open the door, close the door or if you need to remove the hot humidity on safety (STEAM EXHAUST POSITION). (*pic\_2*)

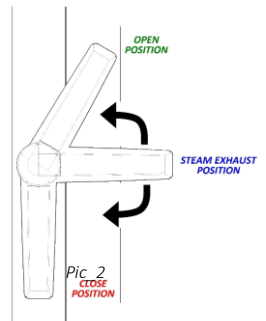

## USE OF THE TROLLEY

- Check and eventually register the height of the trolley (that it is fix) with the ovens to make sure that the trolley goes inside the cooking chamber perfectly. In case adjust the oven feet.

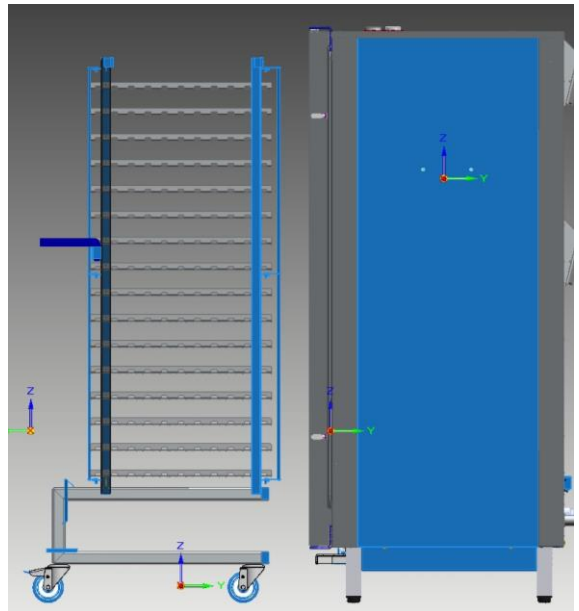
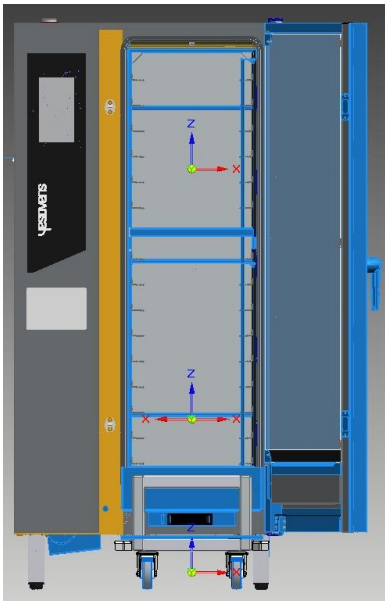
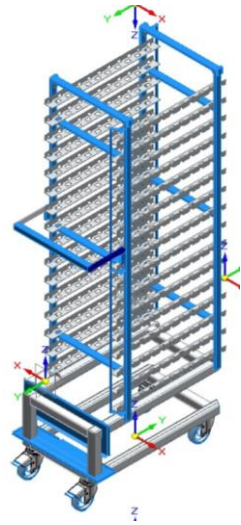

- Lock the trays after placing the block in the correct position. (*pic\_4*)
- Lock the wheels at each trolley insertion.
- Pay attention to handling the trolley when it contains hot liquids.
- Pay attention the inclination of trolley.

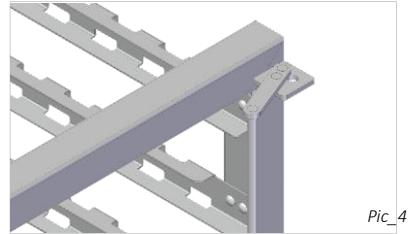
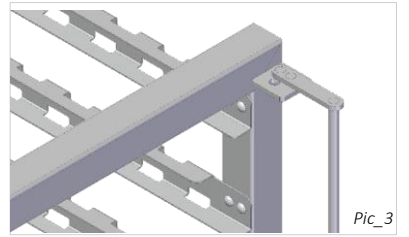

- Fix the bracket in position lock with the screw insert in the packaging, it used for hang up the trolley handle (*pic\_5*).

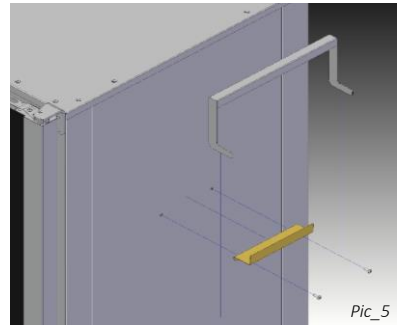

# CLEANING AND MAINTENANCE

## FILLING THE DETERGENT BOX

The equipment is for professional use only and must be used by trained personnel.

Detergent and Limescale Box position (pic\_1)

To fill the box open the door, remove the rack, pull completely forward the box by the handle, remove the blue cover of the tank and pour in the detergent or limescale.

Then close the tray compartment up to its mechanical stop to prevent the parts protruding.

Version with single box: only detergent plastic tank (pic\_2).

Version with double box: detergent plastic tank and limescale plastic tank (pic\_3).



Pay particular attention when pouring the liquids inside the tanks; **during this operation protection gloves are compulsory.**



Pic\_1

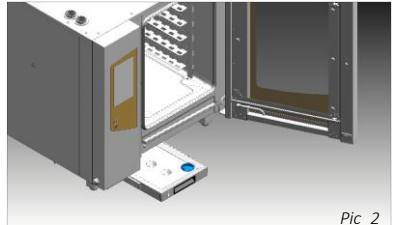

Pic\_2

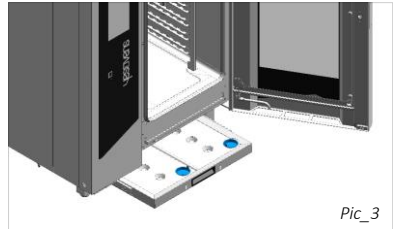

Pic\_3

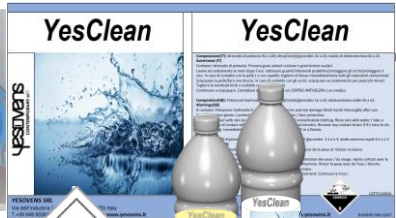

Pic\_4



**USE ONLY YESCLEAN AND YESCAL TO FILL THE TANKS.**



## FILLING THE DETERGENT BOX ON THE SLIM OVENS

The equipment is for professional use only and must be used by trained personnel.

Detergent box positioned in the bottom part rear the door (*pic\_1*).



To fill the box open the door, remove the rack, pull completely forward the box by the handle, remove the blue cover of the tank and pour in the detergent or limescale.

Then close the tray compartment up to its mechanical stop to prevent the parts protruding.

For Limescale connect directly the bottle or an external box, filled with the product, to the dedicated junction located at the rear of the oven.

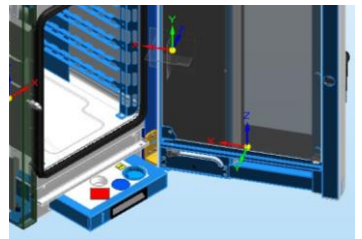

Pay particular attention when pouring the liquids inside the tanks; **during this operation protection gloves are compulsory.**

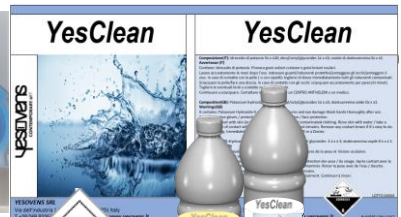

**USE ONLY YESCLEAN AND YESCAL TO FILL THE TANKS.**

# FILLING THE DETERGENT BOX ON THE RACK – TROLLEY OVENS

The equipment is for professional use only and must be used by trained personnel.

Detergent and Limescale box positioned in the bottom part rear the door (*pic\_1*).

To fill the box open the door, remove the rack, pull completely forward the box by the handle, remove the blue cover of the tank and pour in the detergent or limescale.

Then close the tray compartment up to its mechanical stop to prevent the parts protruding.



*Pic\_1*

Version with single box: only detergent plastic tank (*pic\_2*).

Version with double box: detergent plastic tank and limescale plastic tank (*pic\_3*).

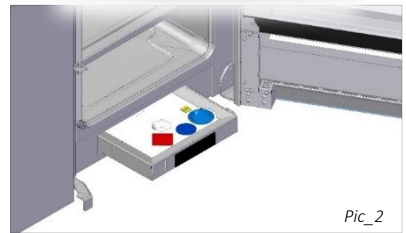

*Pic\_2*

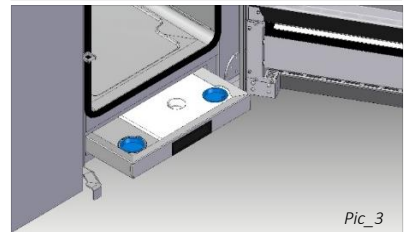

*Pic\_3*



Pay particular attention when pouring the liquids inside the tanks; **during this operation protection gloves are compulsory.**

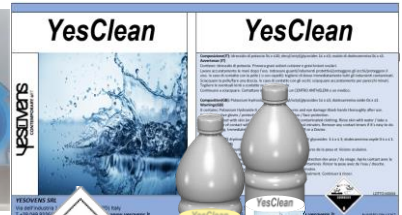

*Pic\_4*



**USE ONLY YESCLEAN AND YESCAL TO FILL THE TANKS.**

## AUTOMATIC CLEANING OF THE COOKING CHAMBER

All Touch ovens are equipped with an automatic washing systems run by a nozzle located in the upper part of the chamber.

To use this function, consult the specific instruction manual enclosed with the present documentation.

The automatic washing system is set on 4 cleaning levels: quick, soft, medium and hard. The final user has to select the type of washing depending on how dirty the chamber is.

In case of residues, clean manually and then repeat the cleaning cycle.

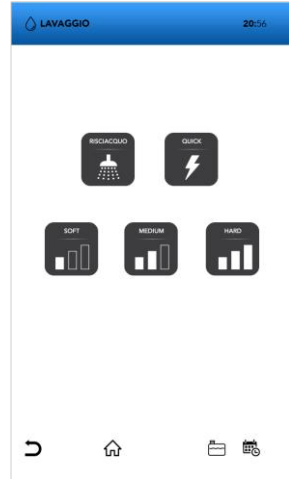

 The **RACK OVENS** must always be washed with the trolley on board.

 Warning concerning possible slippery floor adjacent to the appliance.

 In case of power failure during washing, start a new cycle or, if the previous cycle was finished, restart from a pre-washing cycle.

 No trolley on board is required for preheating on the **RACK OVENS**.

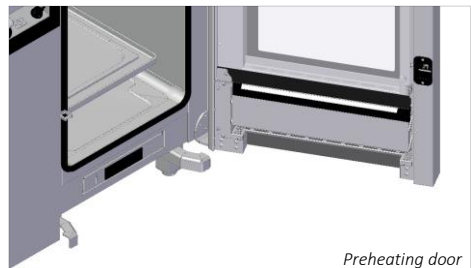
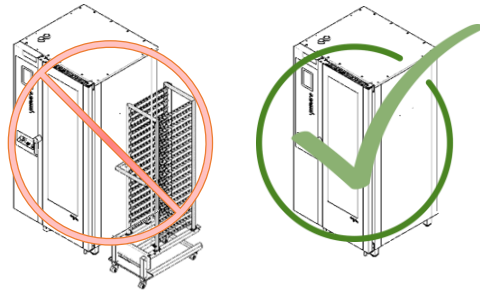



# MANUAL CLEANING OF THE COOKING CHAMBER

In compliance with the regulations in force, the oven's perfect hygienic conditions must be guaranteed; the oven must be cleaned and disinfected as thoroughly as possible, both externally and internally at the end of every day and/or work shift.

Clean and disinfect the oven carefully on a daily basis to prevent biological risks due to the proliferation of mould, bacteria, etc. or build ups that might damage the operation of the oven itself.

 It is important to electrically disconnect the equipment when cleaning must take place (frequently).

 It is essential for the oven to be cleaned daily when it is at a temperature between 40 and 50°C.

 Do not use any abrasive, aggressive or corrosive detergents.

 Do not use these substances to clean the floor underneath the oven either.

 Do not use abrasive pointed tools.

 Do not use abrasive sponges.

 Do not use high pressure cleaners with hot water jets and high-pressure steam.

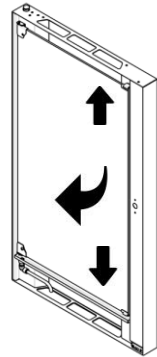
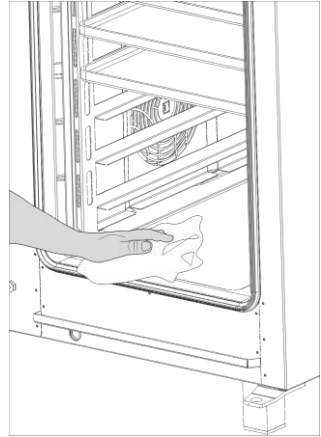

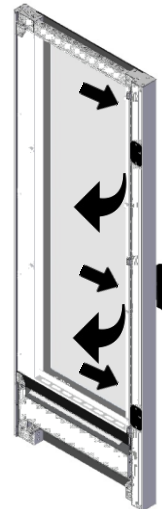

Oven door



Rack oven door

## CLEANING THE GLASS

 Wait for the glass to cool down.

 Use a soft cloth soaked in a little soapy water or a glass-cleaning detergent.

## REPLACEMENT OF SELECTED COMPONENTS

 The replacement of components and their adjustment is classed as a corrective maintenance and must therefore be carried out by an authorised and qualified person (Service Centre).

 Before starting any repair or maintenance operations, disconnect the main switch in order to interrupt the power supply to the oven. Close the water supply taps also.



## OVEN LAMPS

Use a screwdriver to remove the lamp, replace the bulb and refit.

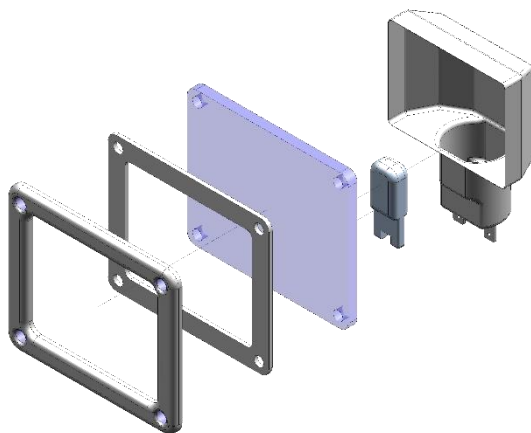

## INSTRUCTION FOR THE USER

Make the user aware of the fact that every repair and/or maintenance operation necessary over time must be performed exclusively by an authorised Service Centre.

Instruct the user that in the event of a fault or malfunction, all supplies must be immediately cut off (water, electricity).

Concerning the power, if the removal of the plug is foreseen, it is clearly indicated that the removal of the plug has to be such that an operator can check from any of the points to which he has access that the plug remains removed. If this is not possible, due to the construction of the appliance or its installation, a disconnection with a locking system in the isolated position is provided.

With the manual at hand, illustrate the functions, safeties, appropriate use, and especially the oven maintenance intervals to the user.

Maintenance must be performed at least once a year.  
For this purpose we recommend signing a maintenance contract.

Keep this manual and the wiring diagram for any interventions.

Notify the user that the manual provided with the oven must be kept in a visible location near the oven to have them always at hand.

Notify the user that certain operation anomalies are often caused by usage errors such as, closed supplies, so it is best to train service staff in the use and operation of the appliance.

Recurrent anomalies require technical support.

Make the user informed regarding the use of personal protection equipment in case of spreading hot food stuff.

Warning concerning slippery floor adjacent to the appliance.

On airborne noise emissions, the A-weighted sound pressure level is below 70 dB(A).

## DISMANTLING AND DISPOSAL

"Implementation of Directives 2002/95/EC, 2002/96/EC and 2003/108/EC, regarding the reduction of hazardous substances in electrical and electronic equipment, and disposal of waste". The "crossed wheelie bin" symbol shown on the equipment indicates that at the end of the product's useful life, it must be collected separately from other waste.

At the end of its useful life, the user must therefore deliver the equipment (or have the equipment delivered) to authorised electrical and electronic waste sorting centres, or return it to the retailer at the same time as purchasing new, equivalent equipment, in a ratio of one to one. Proper waste sorting for the subsequent recycling, treatment and environmental disposal of decommissioned equipment contributes to preventing potentially negative impacts on the environment and on human health, encouraging the reuse and/or recycling of the materials composing the equipment. The incorrect disposal of the product by the user shall result in the application of fines provided for by current legislation.



## COMPLIANCE WITH REGULATIONS AND STANDARDS

The ovens comply with the safety requirements of the following European Directives and their relative standards:

- Machinery Directive 2006/42/EC and its subsequent amendments
- Low Voltage Directive 2006/95/EC and subsequent amendments (EN 60335-1, EN 60335-2, EN 62233:2008 and EN 61000-4 standards)
- Electromagnetic Compatibility (EMC) Directive 2004/108/EC and its subsequent amendments (EN 50165, EN 55014, EN 50366 and EN 61000-4 standards).

Following this compliance, the manufacturer declares that its products comply with the European legislation in force and are therefore stamped with the appropriate CE mark allowing them to be marketed in European countries.

## MAINTENANCE CHECK LIST

Follow the indication below to have the oven always in the correct state and to respect the HACCP rules.

For all the damage and the extraordinary maintenance it must be called qualified personnel and used original spare part.

- Wash and clean the oven with a washing program (not rinse) at least 1 time in a day.
- Clean manually the cooking chamber if the oven is not equipped with washing.
- Wash the boiler every 10 Hours of steam with boiler.
- Wash the clima control at least 1 time in a week.
- Install the water treatment filter for the steaming. (Yesovens optional)
- Clean the air flow filter at least 1 time a month.
- Open the fan protection and check the state of the heating element and fan.
- Open the technical compartment and check the state of the components (contactors, motors, boards).
- Check the state of the washing/steam circuit and look the pipes (the pipes must not to be rigid).
- Check and touch the door gasket.  
If the gasket is not perfect, and is rigid- hard please replace it.



## ALARMS AND WARNING



The alarms block the oven and bring it back to the stand-by screen.



The warnings do not block the oven, but indicate an anomaly that must be resolved as soon as possible.

WARNING  
EXAMPLE



ALARM  
EXAMPLE

WARNING CODE	COMMUNICATION ON DISPLAY	ACTIONS
W01	Detergent in exhaustion.	Recharge detergent.
W02	Limescale in exhaustion.	Limescale detergent.
W03	Failure to read the vapor removal probe reading.	Contact Service. The oven will continue to work.
W04	Warning missed heart probe reading during probe operation.	Insert core probe. The oven does not allow the use of cooking that involves the use of the probe.
W05	Warning not reading climatic probe (where present).	Contact Service. NO ACT will appear on the screen.
W06	Abnormal power-off to power failures.	Oven in stand-by.
W07	Abnormal interruption of the chamber washing cycle.	Stand by, automatic rinsing phase. Wait for restoration of security conditions.
W08	Abnormal interruption of the steamer wash cycle.	Stand by, automatic rinsing phase. Wait for restoration of security conditions.
W09	Abnormal interruption of the climatic probe washing cycle.	Stand by, automatic rinsing phase. Wait for restoration of security conditions.
W10	Power supply interruption during cooking phases.	Oven in stand-by.
W11	Execute boiler washing	It is strongly recommended not to neglect this signal and to perform the boiler cleaning as soon as possible

## ALARMS AND WARNING

ALARM CODE	COMMUNICATION ON DISPLAY	ACTIONS
E01	Lack of water.	Check water connection and relative pressure. Minimum pressure 2 bar.
E02	Cooking chamber temperature malfunction alarm.	Contact Service.
E03	Motor temperature malfunction alarm.	Contact Service.
E04	Steamer temperature malfunction alarm.	Contact Service. The oven excludes the steamer, but it will make working with direct humidification. BOILERLESS will appear on the display.
E05	Alarm exceeding working temperature threshold in the room.	Contact Service.
E06	Failure alarm room probe reading.	Contact Service.
E07	Engine rpm reading alarm.	Contact Service.
E08	Alarm connection power board	Contact Service.
E09	Maximum temperature alarm card in the technical compartment.	Contact Service.
E10	Alarm exceeding working temperature steamer.	Contact Service. The oven excludes the steamer, but it will make working with direct humidification. BOILERLESS will appear on the display.
E11	Alarm Failure to read steamer water level.	Contact Service. The oven excludes the steamer, but it will make working with direct humidification. BOILERLESS will appear on the display.
E12	Failure alarm steamer temperature probe reading.	Contact Service. The oven excludes the steamer, but it will make working with direct humidification. BOILERLESS will appear on the display.
E13	Alarm Failure to read steamer drain, valve malfunction.	Contact Service. The oven excludes the steamer, but it will make working with direct humidification. BOILERLESS will appear on the display.

**[www.yesovens.it](http://www.yesovens.it)**

# CONTEMPORARY/aRT

## **Yesovens srl**

Via dell'industria, 1  
35010 Borgoricco (PD) – Italy  
T. +39 049.9336455  
T. +39 049.9335611  
info@yesovens.it  
www.yesovens.it